



COLLEGE of AMERICAN
PATHOLOGISTS

Recommendations/Requirements for Molecular Proficiency Testing

Published Date:

9/12/2024

Legend of Terms

- CLIA = Clinical Laboratory Improvement Amendments
- CNV = Copy number variant
- EBV = Epstein-Barr virus
- FISH = Fluorescence *in situ* hybridization
- FFPE = Formalin-fixed, paraffin-embedded
- GIST = Gastrointestinal stromal tumor
- H&E = Hematoxylin and eosin stain
- HPV = Human papillomavirus
- ISH = *In situ* hybridization
- NGS = Next-generation sequencing
- PET = Paraffin-embedded tissue
- PT = Proficiency testing
- SHM = Somatic hypermutation
- SNV = Single nucleotide variant

Additional Information Regarding CAP Survey Programs

- For additional information regarding the PT programs mentioned throughout these flow charts, please refer to the Surveys Catalog by clicking on the Catalog and Ordering Information link under the Laboratory Improvement header at www.cap.org.

Table of Contents

Topic	Page Number
Requirements for CAP-accredited laboratories and PT referral	4 – 5
Information on germline molecular testing	6 – 7
Information on molecular oncology testing	8 – 12
Information on NGS bioinformatics	13
Information on ISH and microarray testing	14 – 15
Information on microbiology and histocompatibility testing	16

PT Requirements for Laboratories Accredited by the CAP

- Participation in PT is integral to the CAP's accreditation program and is required for most tests for which the laboratory reports results.
- For analytes that require PT, each laboratory must enroll and participate in a CAP-accepted PT program. In the following flow charts, required programs/analytes will be indicated by an asterisk (*).
- For tests that do not require enrollment in a CAP-accepted PT program, the laboratory must perform an alternative assessment semi-annually to determine the reliability of testing. The most common way to do this is by purchasing an external PT product, if available. Other acceptable alternative assessment procedures are split sample analysis with reference or other laboratories, split samples with an established in-house method, assayed materials, or other suitable and documented means. It is the responsibility of the director to define such alternative assessment procedures and the criteria for successful performance. Any program without an asterisk (*) in the following flow charts is **not** a required PT program and may be used to satisfy alternative assessment requirements. **Note:** *International laboratories are required to enroll in CAP PT for all tests/activities if a CAP PT program is available.*
- For a full list of required programs/analyte(s), please refer to the Analyte/Procedure Index in the Surveys Catalog.
- **Note:** the paths within the following flowcharts are not mutually exclusive.

PT Referral

- The NGS programs [NGS—Germline (NGS), NGS—Solid Tumor (NGSST) and NGS—Hematologic Malignancies (NGSHM)] are for laboratories performing wet bench, bioinformatic, and interpretative components of the assay. If a distributive testing model is used (eg, different parts of the NGS assay are performed by laboratories with different CLIA/CAP numbers), laboratories **cannot** participate in the NGS, NGSST, and/or NGSHM PT programs as is (ie, without modifications to the overall process). To do so, laboratories would be subject to sanctions for PT referral.
- Laboratories using any other distributive testing process must use alternative approaches to fulfill the requirement for PT enrollment/alternative assessment. Please note that distributive testing laboratories can use PT materials for part of their laboratory quality management program; laboratories should contact the CAP for additional details.

Germline Molecular Flow Chart

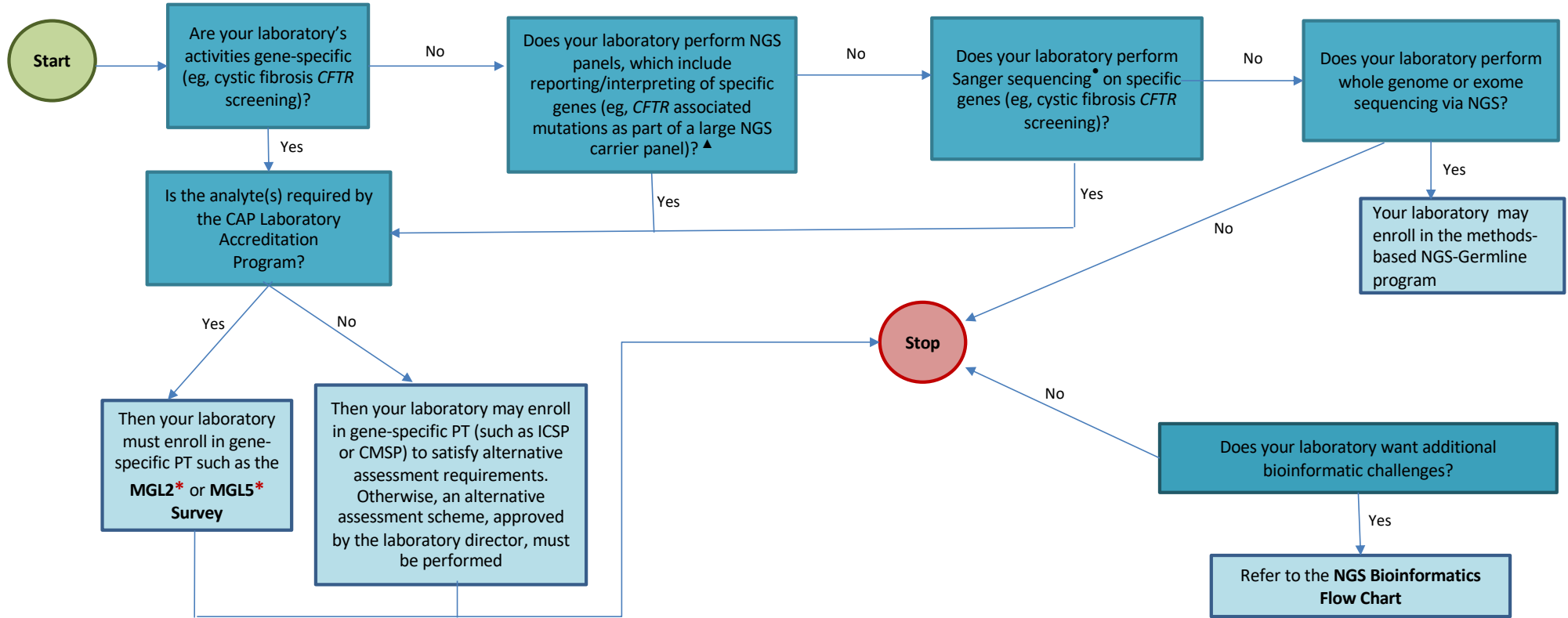

▲A panel is defined as the reporting/interpreting of specific genes on a consistent, ongoing basis, regardless of technical approach (eg, performing exome sequencing on a preselect group of genes would be considered a panel). *Note:* A panel may contain required and nonrequired analytes; laboratories must enroll in gene-specific PT for required analytes and may use current PT programs to satisfy alternative assessment requirements for nonrequired analytes.

• If gene-specific PT is not available or not required, your laboratory may enroll in a methods-based Sanger sequencing (SEC or SEC1) program to satisfy alternative assessment requirements.

Additional gene-specific PT programs:

AAT*, APOE*, BRCA*, CMSP, HGM*, ICSP, IMD*, MGL1-5*, PGX*, RETT*, and TPM*

*CAP Accreditation Program required program/analyte. Any program **without** an asterisk (*) reflected in this flow chart is not a required PT program; refer to page 5 for information regarding alternative assessment.

Germline Molecular FAQs

Q: My laboratory performs a hearing loss panel by NGS in which we report findings for 100 genes, including *GJB2* (Connexin 26). Which PT program should I enroll in?

A: Your laboratory must enroll in gene-specific PT for Connexin 26 (MGL3* program) if it is accredited by the CAP. If there is no gene-specific PT for the remaining genes, your laboratory may enroll in the NGS-Germline program to satisfy alternative assessment requirements. Participation in MGL3* for Connexin 26 (*GJB2* gene) will not satisfy alternative assessment requirements for the entire hearing loss panel.

Q: My laboratory tests for rare disorders (eg, Aarskog-Scott syndrome, Von Hippel-Lindau syndrome) by sequencing. What CAP PT is available to satisfy alternative assessment requirements for this assay?

A: Since there is no gene-specific PT available, your laboratory can enroll in the SEC or SEC1 program to satisfy alternative assessment requirements for Sanger sequencing and the NGS-Germline program to satisfy alternative assessment requirements for NGS. All 3 programs are considered methods-based programs.

Q: My laboratory does exome sequencing on diagnostic odyssey specimens. We report pathogenic/likely pathogenic and variants of uncertain significance that are present in any gene that fits the phenotype. What CAP PT is available to satisfy alternative assessment requirements for this assay?

A: In a case like this, laboratories may enroll in the NGSE program (proband only) or NGSET program (proband plus parents) to satisfy alternative assessment requirements.

*CAP Accreditation Program required program/analyte.

General Molecular Oncology Flow Chart[≠]

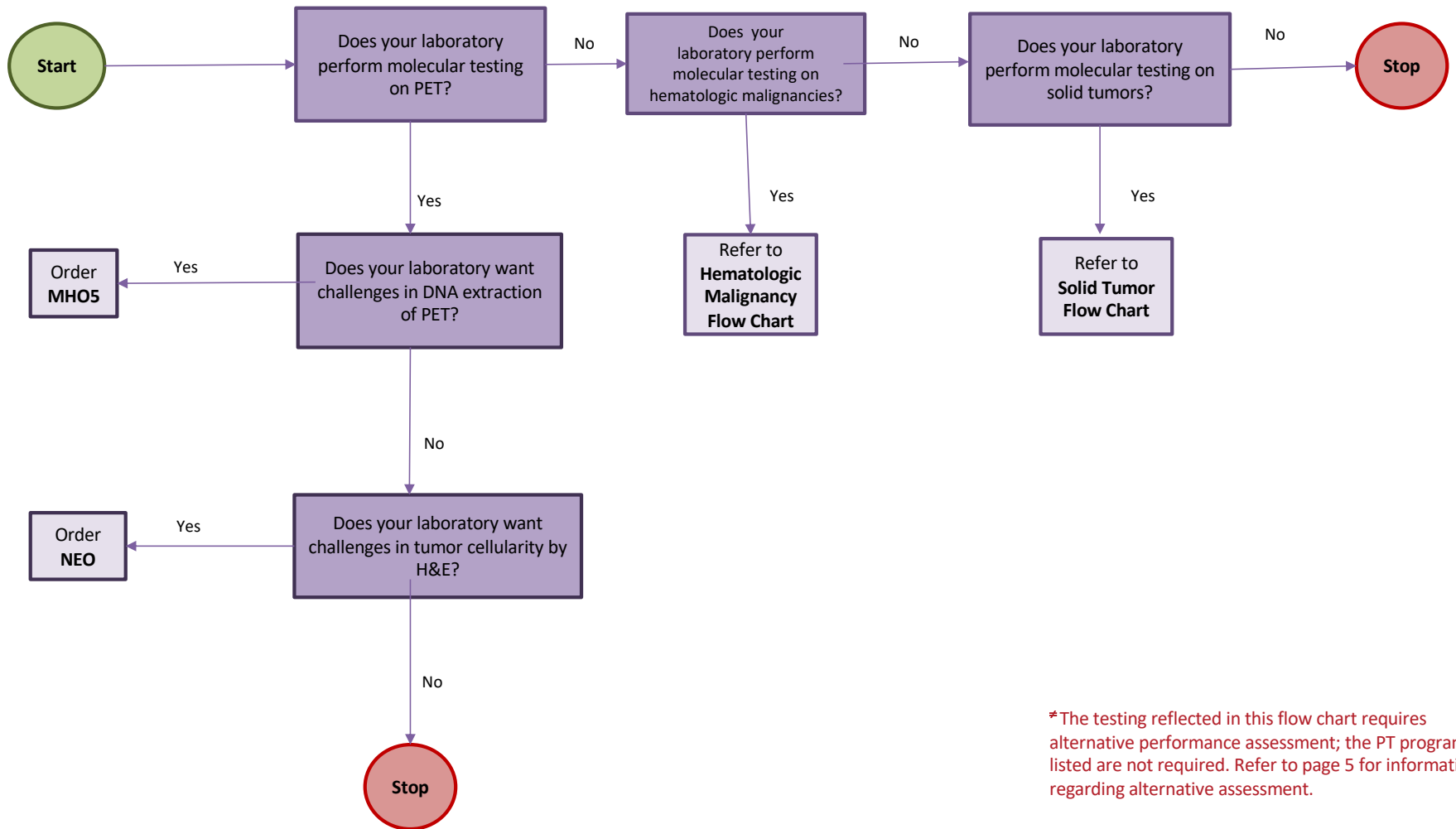

*The testing reflected in this flow chart requires alternative performance assessment; the PT programs listed are not required. Refer to page 5 for information regarding alternative assessment.

Solid Tumor Flow Chart

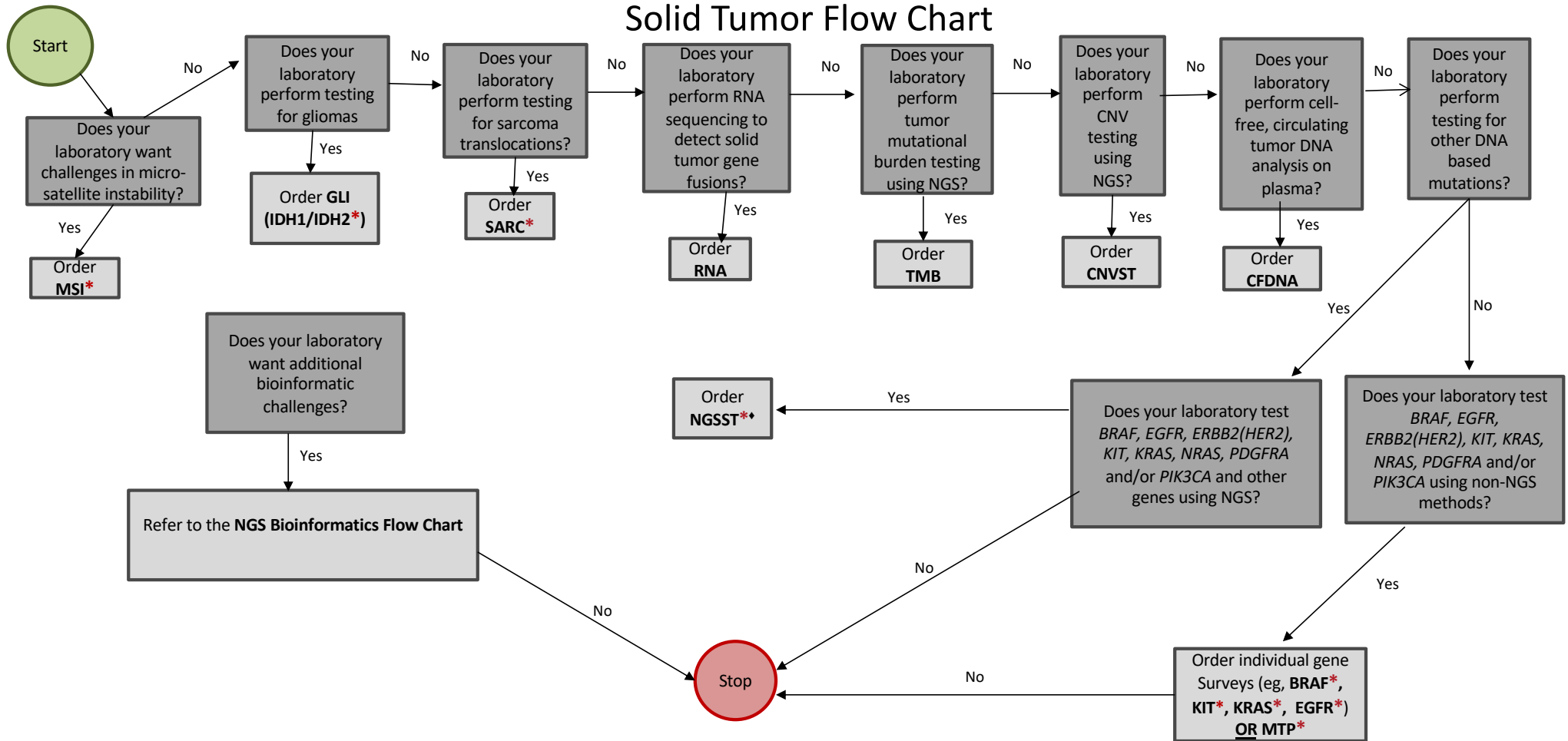

*CAP Accreditation Program required program/analyte. Laboratories testing for *BRAF*, *EGFR*, *ERBB2(HER2)*, *KIT*, *KRAS*, *NRAS*, *PDGFRA* and/or *PIK3CA* using non-NGS methods **must** enroll in the MTP program **or** the individual gene programs (*EGFR*, *KIT*, *KRAS*, and *BRAF*). Laboratories using NGS for other genes, including *BRAF*, *EGFR*, *ERBB2(HER2)*, *KIT*, *KRAS*, *NRAS*, *PDGFRA* and/or *PIK3CA*, **must** enroll in NGSST. Any program **without** an asterisk (*) reflected in this flow chart is not a required PT program; refer to page 5 for information regarding alternative assessment.

♦ *Note:* If there are alternative assays used to confirm NGS findings, these should have appropriate alternative assessment performed. Alternative assessment options can include participation in CAP PT programs.

Hematologic Malignancy Flow Chart

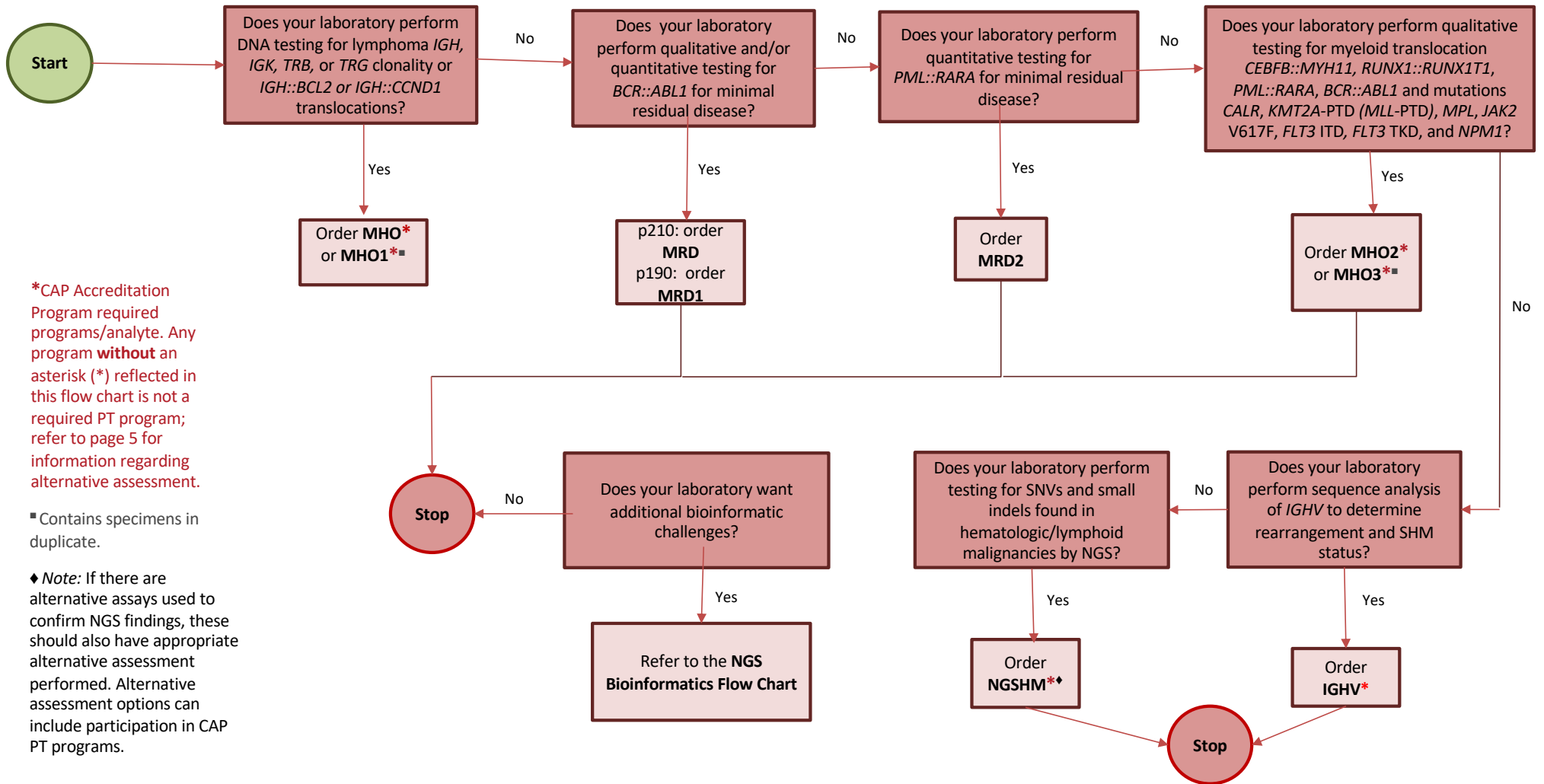

*CAP Accreditation Program required programs/analyte. Any program **without** an asterisk (*) reflected in this flow chart is not a required PT program; refer to page 5 for information regarding alternative assessment.

** Contains specimens in duplicate.

◆ Note: If there are alternative assays used to confirm NGS findings, these should also have appropriate alternative assessment performed. Alternative assessment options can include participation in CAP PT programs.

Molecular Oncology FAQs

Q: My laboratory performs a 50 gene NGS-based assay designed to detect somatic SNVs and small indels observed in solid tumors. What PT program should I enroll in?

A: Enrollment in NGSST* is required for CAP-accredited laboratories.

Q: My laboratory performs a 50 gene NGS-based assay designed to detect somatic SNVs and small indels observed in solid tumors. In addition, we have individual Sanger sequencing-based assays for *KRAS*, *KIT*, *BRAF*, and *EGFR*. Can we use the NGSST program to satisfy requirements for all these analytes/genes?

A: In this case, the laboratory **must** order the NGSST* program for their NGS-based solid tumor assay. The laboratory may order either MTP* or the individual gene programs (*KRAS**, *KIT**, *BRAF** or *EGFR**) for the *KRAS*, *KIT*, *BRAF*, and *EGFR* Sanger sequencing assay, but is not required to.

Q: My laboratory performs a 50 gene NGS-based assay designed to detect somatic SNVs and small indels observed in hematologic malignancies. What CAP PT program should I enroll in?

A: Enrollment in NGSHM* is required for CAP-accredited laboratories.

*CAP Accreditation Program required program/analyte.

Molecular Oncology FAQs (continued)

Q: My laboratory performs a 50 gene NGS-based assay designed to detect somatic SNVs and small indels observed in hematologic malignancies. In addition, we have individual PCR-based assays for *JAK2*, *FLT3*, and *NPM1*. Can we use the NGSHM program to satisfy requirements for all these analytes/genes?

A: In this case, the laboratory **must** order the NGSHM* program for their NGS-based solid tumor assay. The laboratory may order MHO2* or MHO3* for the individual PCR-based assays, but is not required to.

Q: Our laboratory performs NGS-based testing for the detection of somatic CNV and structural variants in solid tumors. What CAP PT is available to satisfy alternative assessment requirements for these assays?

A: In this case, the laboratory can enroll in the CNVST program for NGS solid tumor CNV analysis to satisfy alternative assessment requirements. Currently, there are no CAP programs for NGS-based detection of structural variants, therefore an alternative assessment scheme, approved by the laboratory director, must be performed (Sample Exchange Registry, etc).

Q: Our laboratory performs NGS-based testing and would like additional bioinformatic challenges in addition to wet-bench challenges. Is there a PT program available for this that may be used to satisfy alternative assessment requirements?

A: Yes, the laboratory may enroll in either NGSB1 (panel-specific) or NGSB4 for solid tumor challenges or NGSB3 (panel-specific) or NGSB5 for hematologic malignancy challenges. Additionally, there is a somatic validated materials portion available with the NGSB4 and NGSB5 programs, which are designed to optimize bioinformatics pipelines, augment validations, and assist with pipeline verification after changes to NGS/bioinformatics processes in addition to offering PT. Refer to the NGS Bioinformatics Flow Chart for additional information.

*CAP Accreditation Program required program/analyte.

NGS Bioinformatics Flow Chart

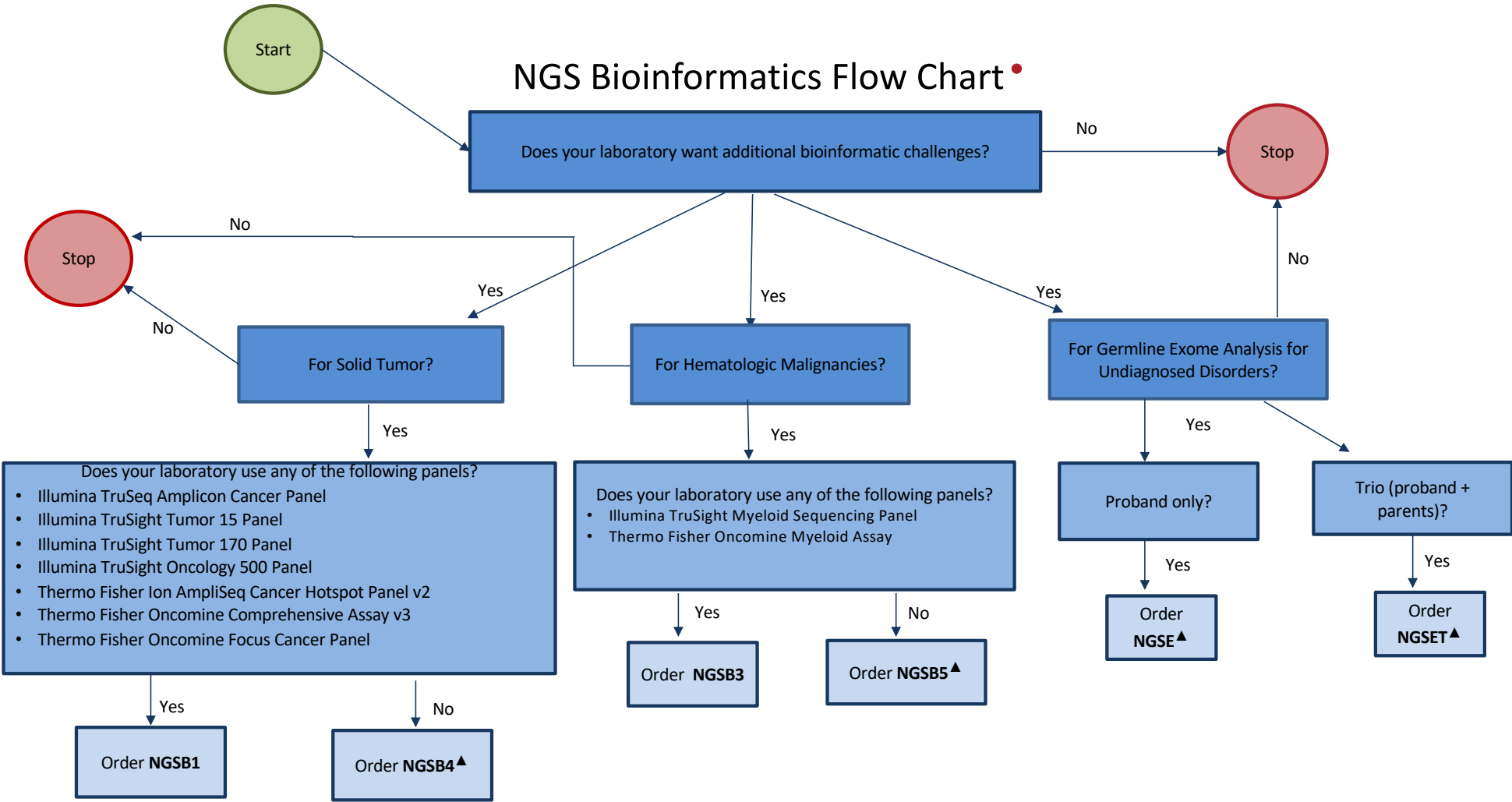

• The testing and PT programs reflected in this flow chart are not required.
 ▲ These programs require laboratories to submit FASTQs or unaligned BAMs to CAP for *in silico* mutagenesis. In addition to the PT portion, NGSB4 and NGSB5 also contain a validated materials portion designed to optimize NGS/bioinformatics processes.

Bioinformatics FAQs

Q: [What are the requirements to participate in these in silico programs \(NGSE, NGSET, NGSB4 or NGSB5\)?](#)

A: Laboratories must provide sequencing data files, paired FASTQs or unaligned BAM, (NGSE/NGSET: exome, NGSB4/NGSB5: panel) generated using their current clinical sequencing protocols from a list of acceptable sources (see description in catalog for each program's list of acceptable cell lines). In addition, a BED file describing the regions targeted and interrogated by your laboratory must be submitted. It is also requested to submit a MD5 (checksum) file in conjunction with each sequencing data file submitted to ensure bioinformatic integrity (this is not a requirement to participate).

Q: [What is the process for submitting sequencing files for this program?](#)

- Prior to the ship date: Sequencing data files must be submitted from acceptable cell lines so it is advised to order an appropriate specimen and sequencing prior to the ship date. See catalog for acceptable cell lines.
- Ship Date: Your CAP lab account contact will receive an email when each program is available (this is the 'ship' date – no physical shipment is sent).
- Interim Due Date: The interim due date is 10 days from the 'ship' date. Laboratories are to upload their files before the interim due date. No interim due date extensions can be granted – files must be uploaded by the interim due date to participate in the program.
- Final Due Date: Approximately 45 days from the interim due date, mutagenized files will be made available for laboratories to download and analyze per the kit instructions.
- An email alert is sent to the lab account contact when files are available for download.

Q: [Can you accept whole genome sequencing files for NGSE, NGSET, NGSB4 or NGSB5?](#)

A: At this time, we are not able to accept these types of files due to size limitations.

ISH Flow Chart

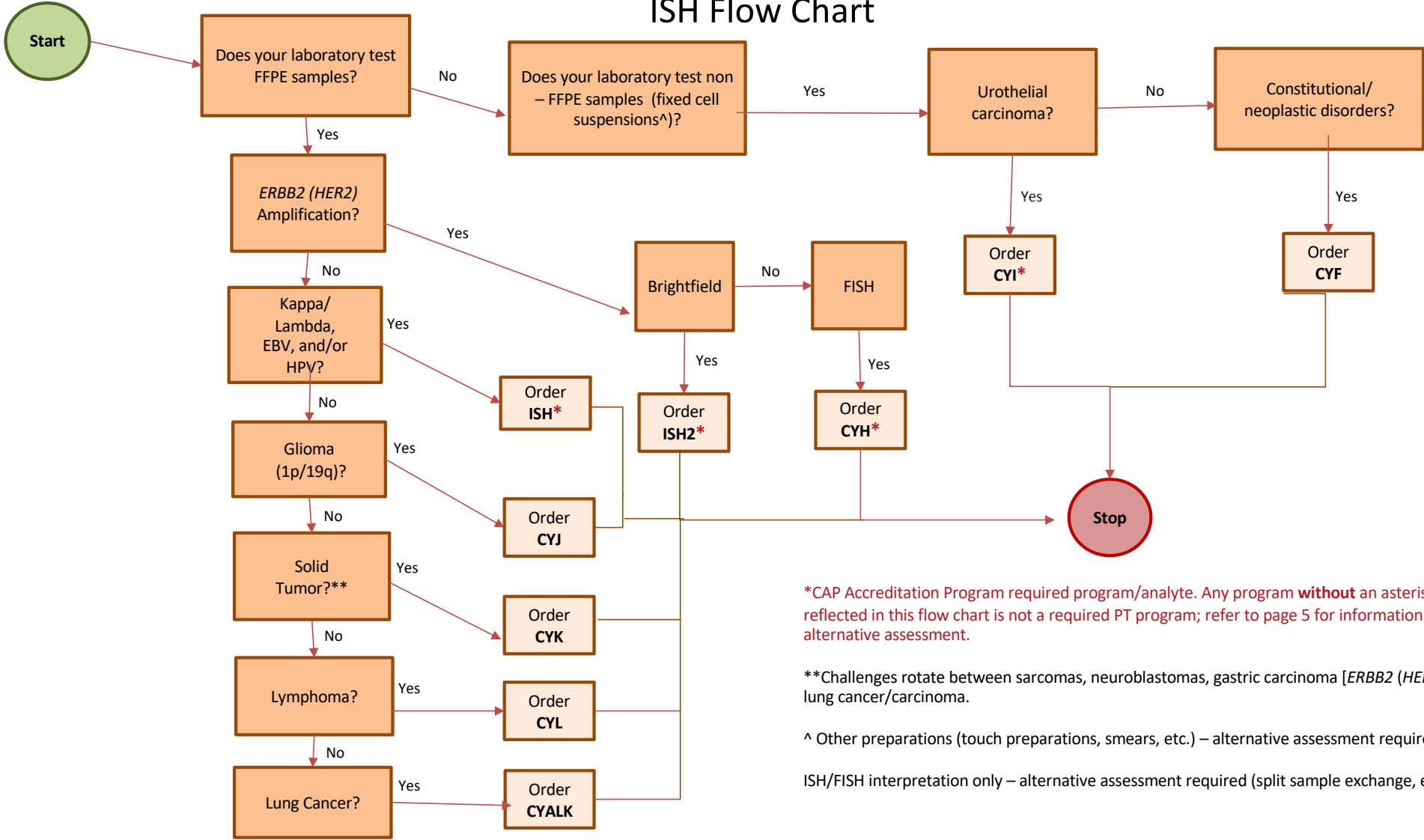

*CAP Accreditation Program required program/analyte. Any program **without** an asterisk (*) reflected in this flow chart is not a required PT program; refer to page 5 for information regarding alternative assessment.

**Challenges rotate between sarcomas, neuroblastomas, gastric carcinoma [ERBB2 (HER2)], and lung cancer/carcinoma.

^ Other preparations (touch preparations, smears, etc.) – alternative assessment required.

ISH/FISH interpretation only – alternative assessment required (split sample exchange, etc.).

Microarray Testing Flow Chart[≠]

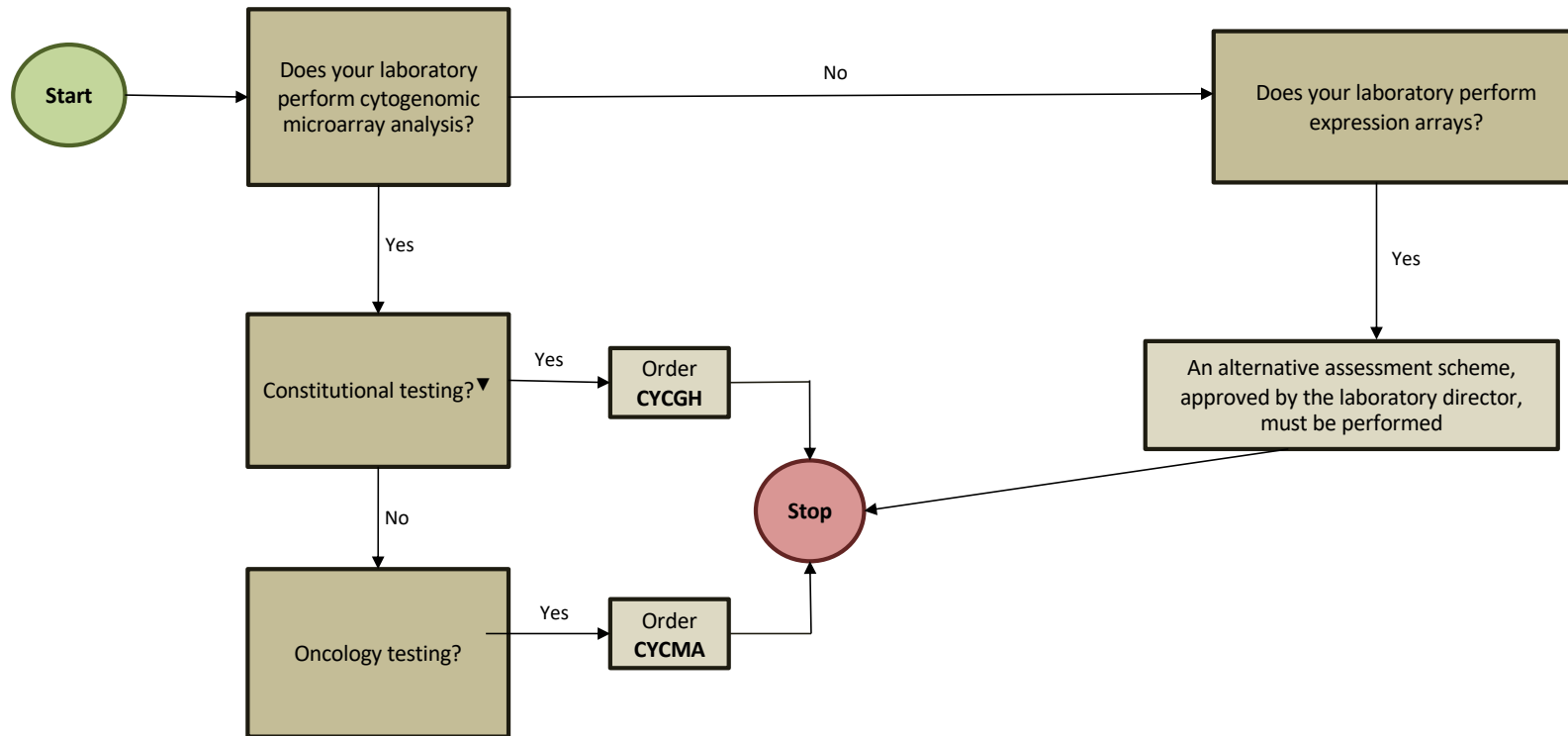

[≠] The testing reflected in this flow chart requires alternative performance assessment; the PT programs listed are not required. Refer to page 5 for information regarding alternative assessment.

▼ CYCGH PT is not applicable to preimplantation genetic diagnosis (PGD) or exon-level array testing. For PGD, alternative assessment is required. For exon-level arrays, gene-specific duplication/deletion PT may be available (eg, *DMD*, *MECP2*) to fulfill alternative assessment requirements or laboratories must identify another form of alternative assessment.

Additional Information for Microbiology and Histocompatibility:

Microbiology:

- If performing patient testing on specimens by molecular methods only, laboratories must meet the regulatory requirements of testing 5 specimens in 3 mailings for each subspecialty, as appropriate. Subspecialties include bacteriology, mycology, virology, and parasitology. The mycobacteriology requirement is 5 specimens tested in each of the 2 mailings.
- If performing molecular testing on patient specimens, in addition to traditional culture methods, alternative assessment is required. Alternative assessment can be met through enrollment in PT programs.

Histocompatibility:

- Regardless of methodology, laboratories should enroll in the appropriate HLA program(s) to meet testing needs.



COLLEGE of AMERICAN
PATHOLOGISTS

